

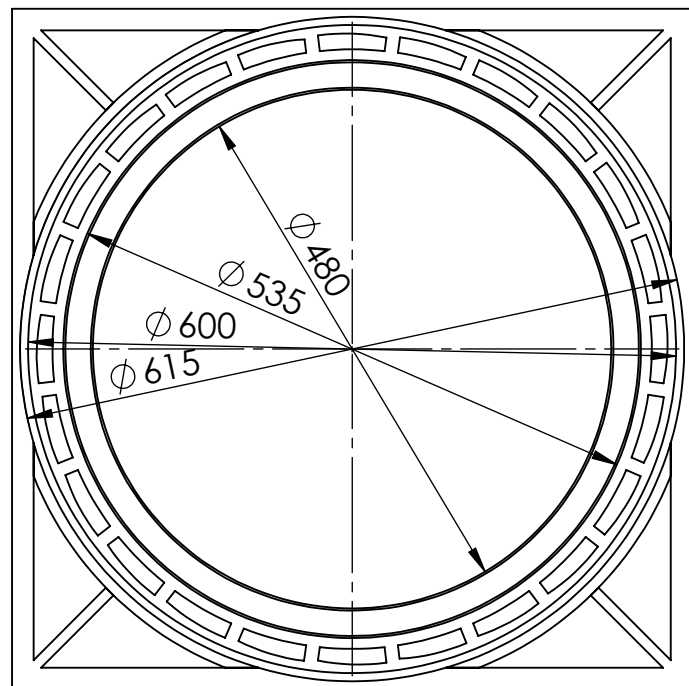

SECTION A-A
SCALE 1 : 7

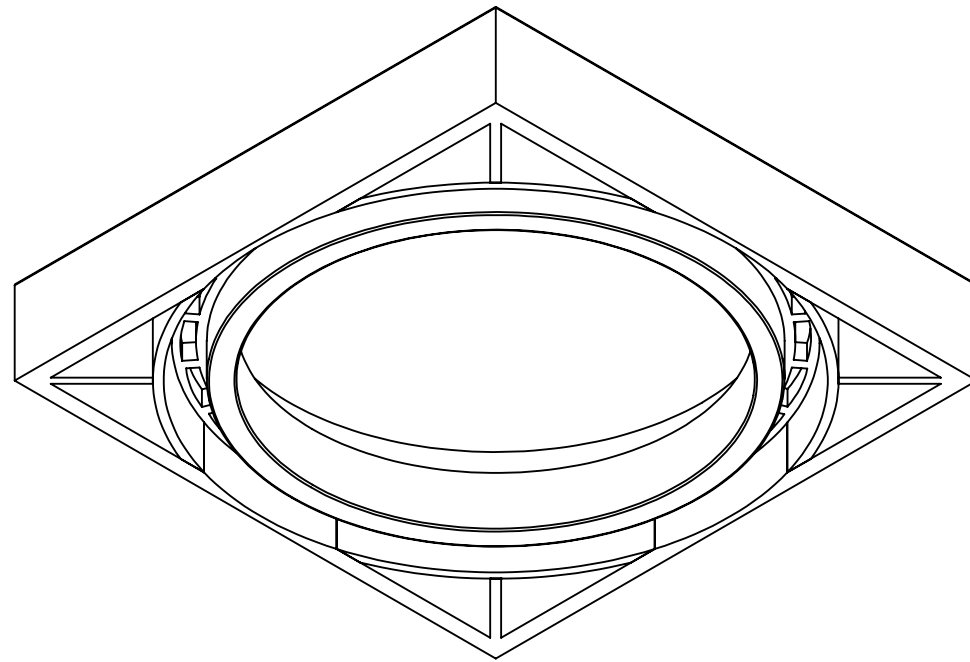
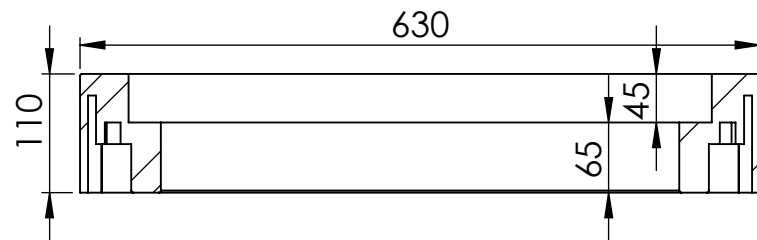

UNLESS OTHERWISE SPECIFIED: DIMENSIONS ARE IN MILLIMETERS SURFACE FINISH: TOLERANCES: LINEAR: ANGULAR:				FINISH:		DEBUR AND BREAK SHARP EDGES		DO NOT SCALE DRAWING		REVISION	
DRAWN				NAME		SIGNATURE		DATE		TITLE:	
CHK'D											
APPV'D											
MFG											
Q.A											
						MATERIAL:		DWG NO. 425 høj firkantet karm		A3	
						WEIGHT:		SCALE:1:10		SHEET 1 OF 1	